

**09009**  
**SIZE:90X90X215cm**



## Cautions in Installation and Using

Thanks for selecting our shower room series. To guarantee safe and normal operation as well as prolong service lifetime. Pls read Instruction carefully before installation.









Note: We are dedicated to improving products quality, find something new in what is old, we would if there is difference in the Instruction until further notice. Any discomfort, we ask your pardon.

### Directory



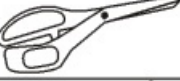

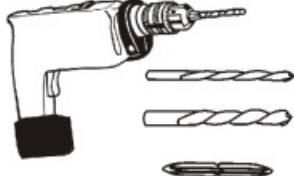



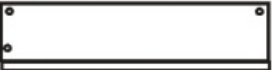
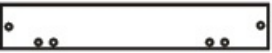
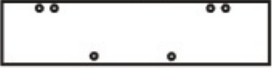

1. Tool contents	-----	2
2. Accessory list	-----	3-4
3. Pipe and drain installation drawing	-----	5
4. Installation Procedure	-----	6-15
5. Notes	-----	16
6. Delivery and storage notice	-----	16
7. Trouble shootings	-----	17

(1)

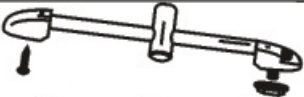

## 一、self provide tool

Name	Tool
Track level bar	
Tape measure	
Ajustable spanner	
Rubber hammer	
Phillips srewdriver	
Scissors	
Glass cement	
Electric drill	
3mm aiguille	
6mm aiguille	
Tap drill	
Inner hexagon spanner	

(2)

二、Partial accessory list			
Item	Name	Accessory	Quantity
1	(1) Roof		1
2	(2) Tub		1
3	(3) Backboard		1
4	(4.1) Left and right glass panel		2
	(4.2) Fixed door glass		1
	(4.3) Flexible door glass		1
5	(5) Hinge		2
6	(6) Handle		1
7	(7) Lifting rod		1
8	(8.1) Hand shower tube		1
	(8.2) Hand shower		1
9	(9) Hot and cold water hose		2
10	(10.1) Back upright profile		2
	(10.2) Front upright profile		1
	(10.3) Door belt		1

(3)

二、Partial accessory list			
Item	Name	Accessory	Quantity
	(10.4) Waterproof belt		1
	(10.5) U belt		2
11	(11) Top shower		1
12	(12) Up fixed hinge		3
13	(13) Down fixed hinge		5
14	(14) Seat		1
15	(15.1) St 4*16mm self tapping screw		4
	(15.2) St 4*12mm self tapping screw		10

(4)

### 三、Pipe and drain installation drawing

Demension : 90\*90\*215cm  
C=Cold water inlet  
H=Hot water inlet  
D=Drain

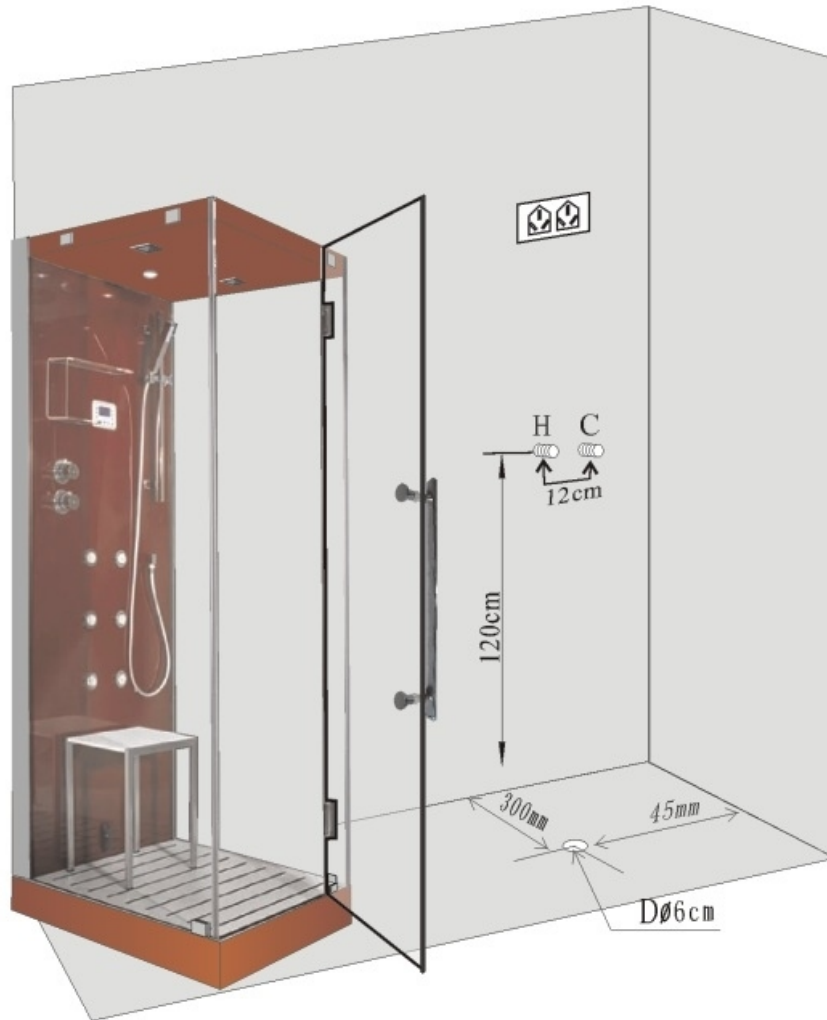

(5)

### 四、Installation Procedure



- (1) Put track level ber on the tub, and adjust foot ' s screw by adjustable spanner, and keep it to the leveling.

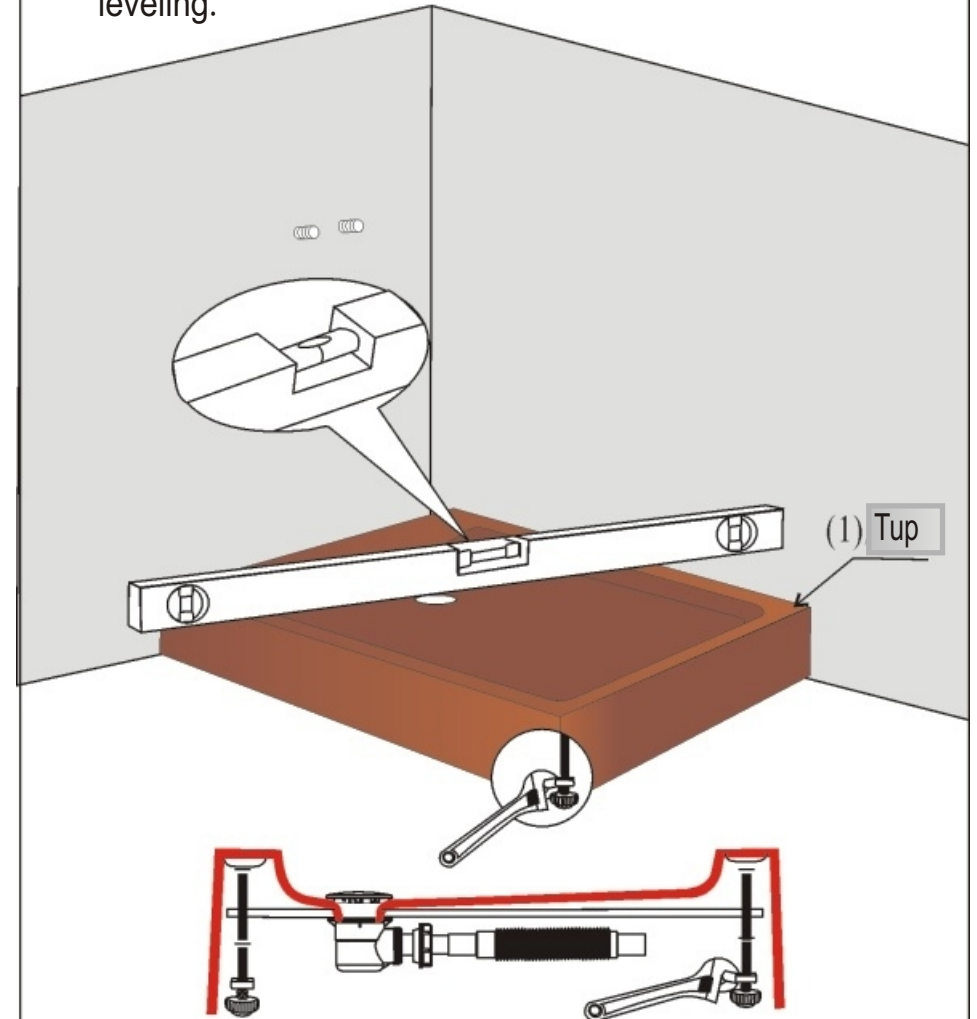

(6)

#### 四、Installation Procedure

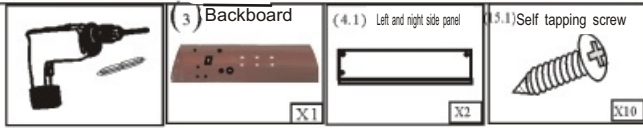

(2) Use (15.1) St 4\*12mm self-tapping screw to make the left Right side panel as well as the backboard vertical.

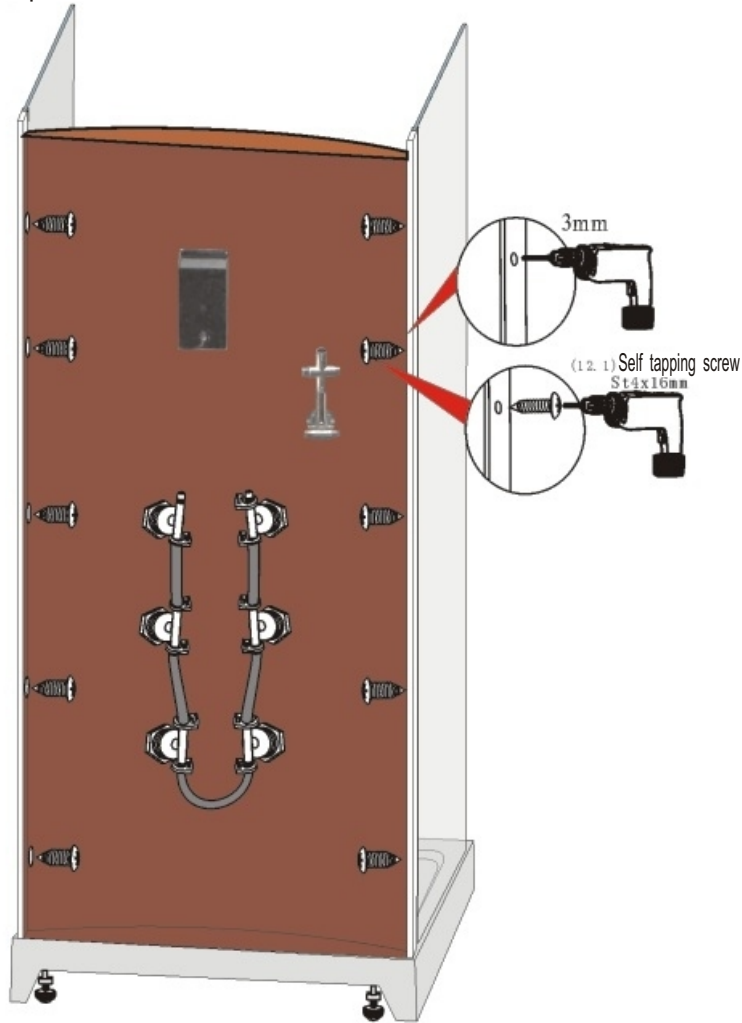

(7)

#### 四、Installation Procedure

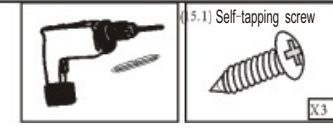

(3) Use (15.1) 4\*12mm self-tapping Screw to fix the backboard and tub.

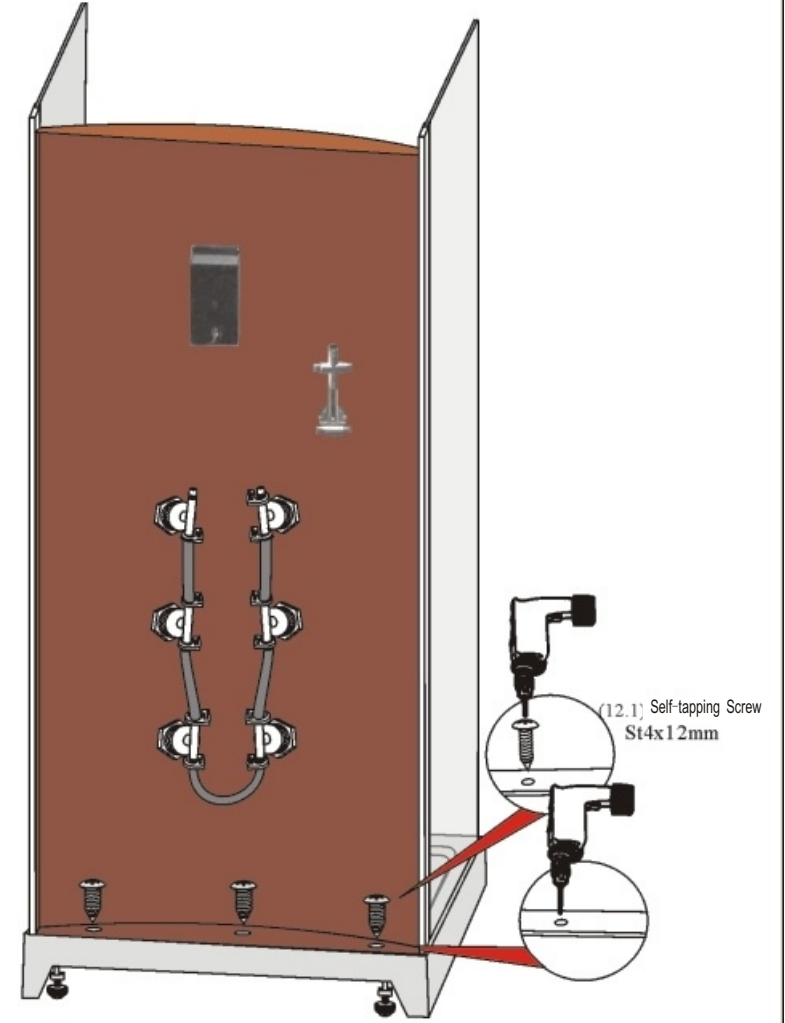

(8)

#### 四、Installation Procedure

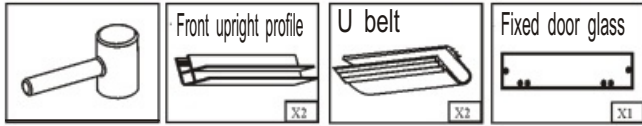

(4) Put U belt on the front fixed glass, make them insert into the front upright profile Use a rubber hammer to fix them .

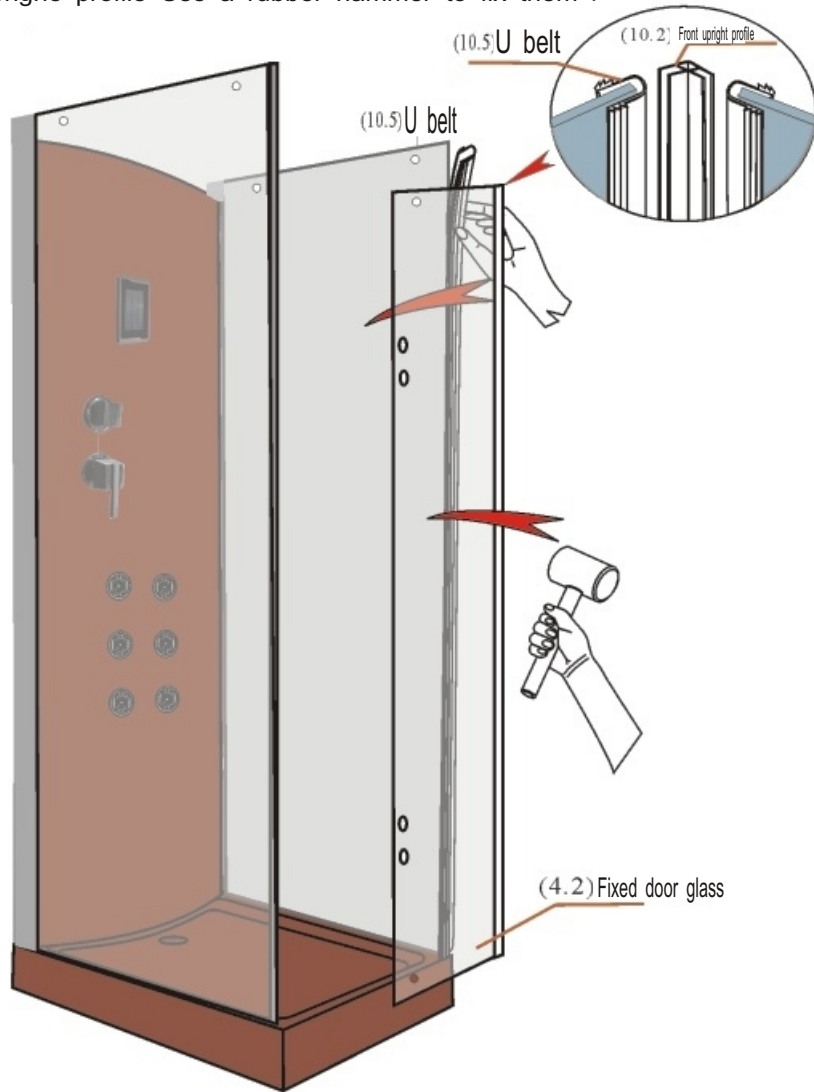

(9)

#### 四、Installation Procedure



(5) put the roof on the backboard, put the up fixed hinge and fix them with Inner hexagon spanner.

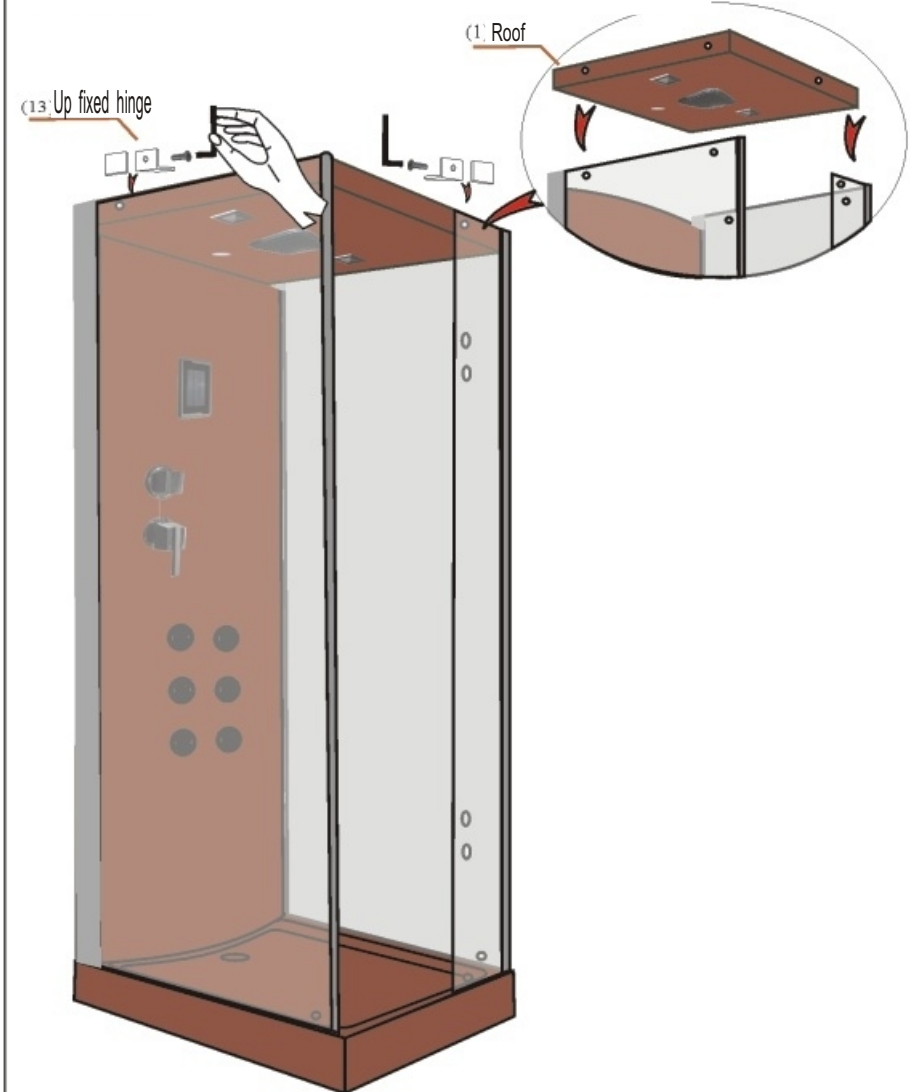

(10)



#### 四、Installation Procedure

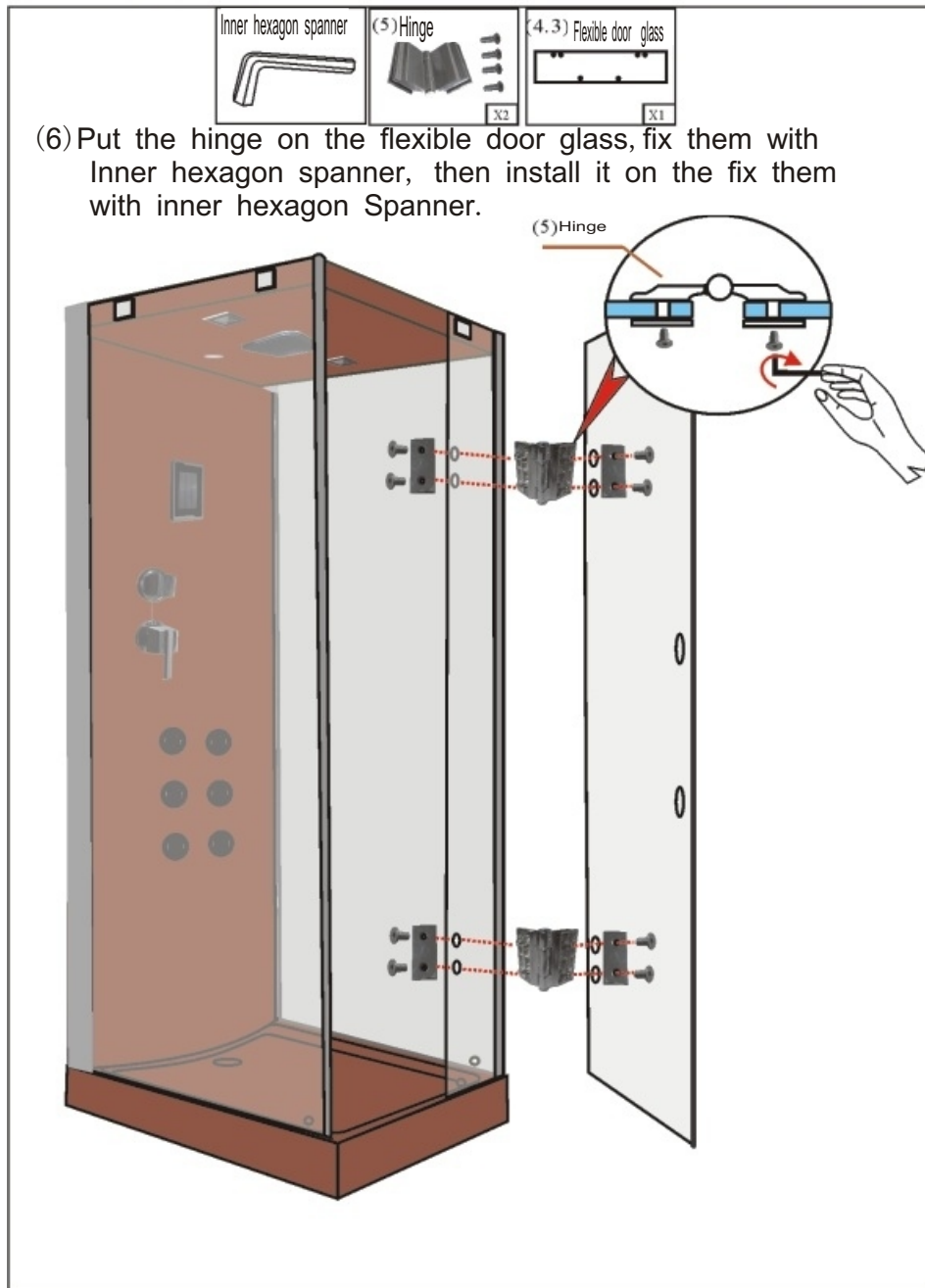

(11)

#### 四、Installation Procedure

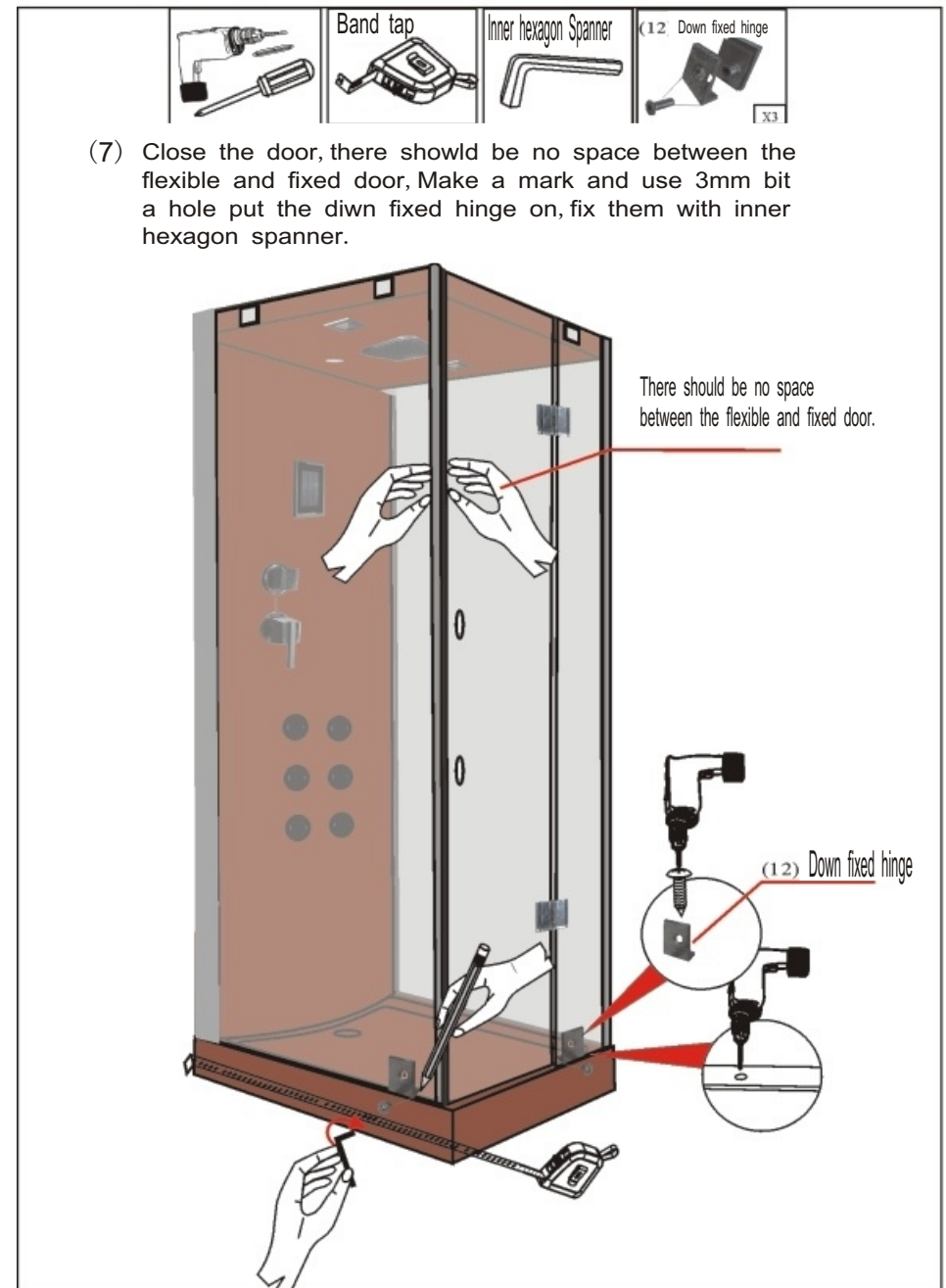

(12)

#### 四、Installation procedure



(8) Installation Lifting rod, hand shower hose and hand shower  
On the backboard Install the handle on the flexible door.

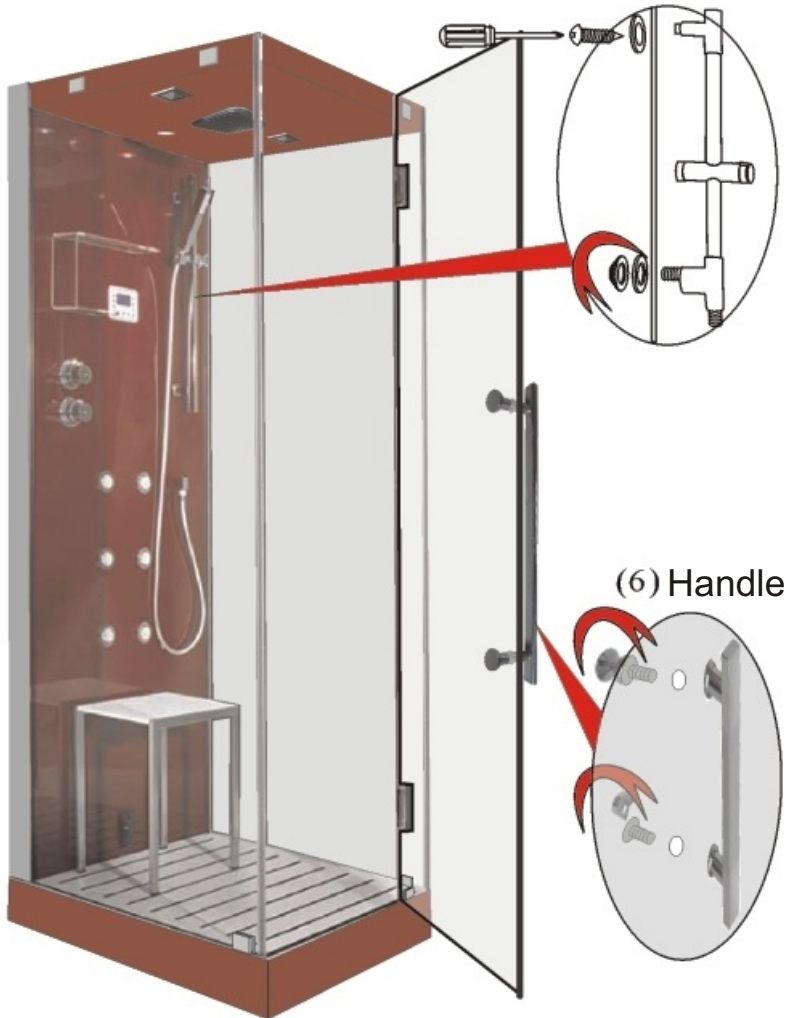

(13)

#### 四、Installation Procedure

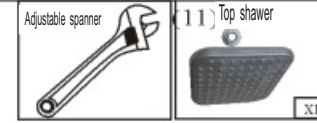

(9) Connect all hoses, Connect the top shower and fix it with adjustable Spanner.

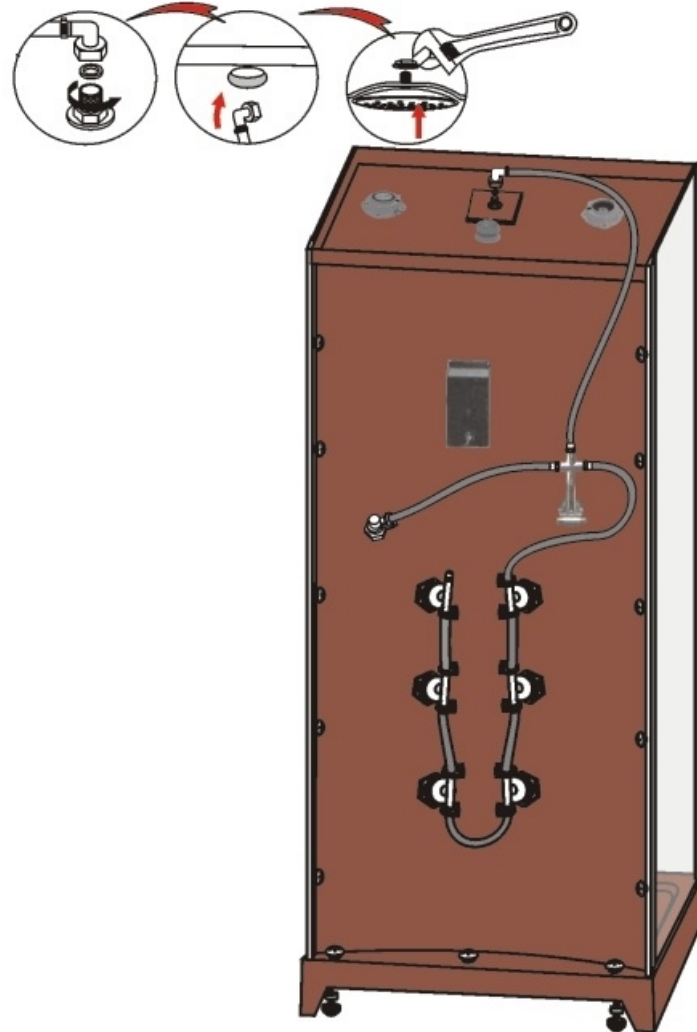

(14)



#### 四、Installation Procedure

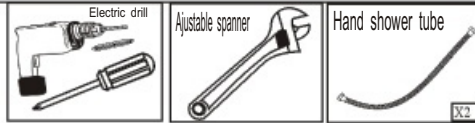

(10) Connect hot and cold water hoses with faucet, fix them with adjustable spanner, connect all wires and electricity.

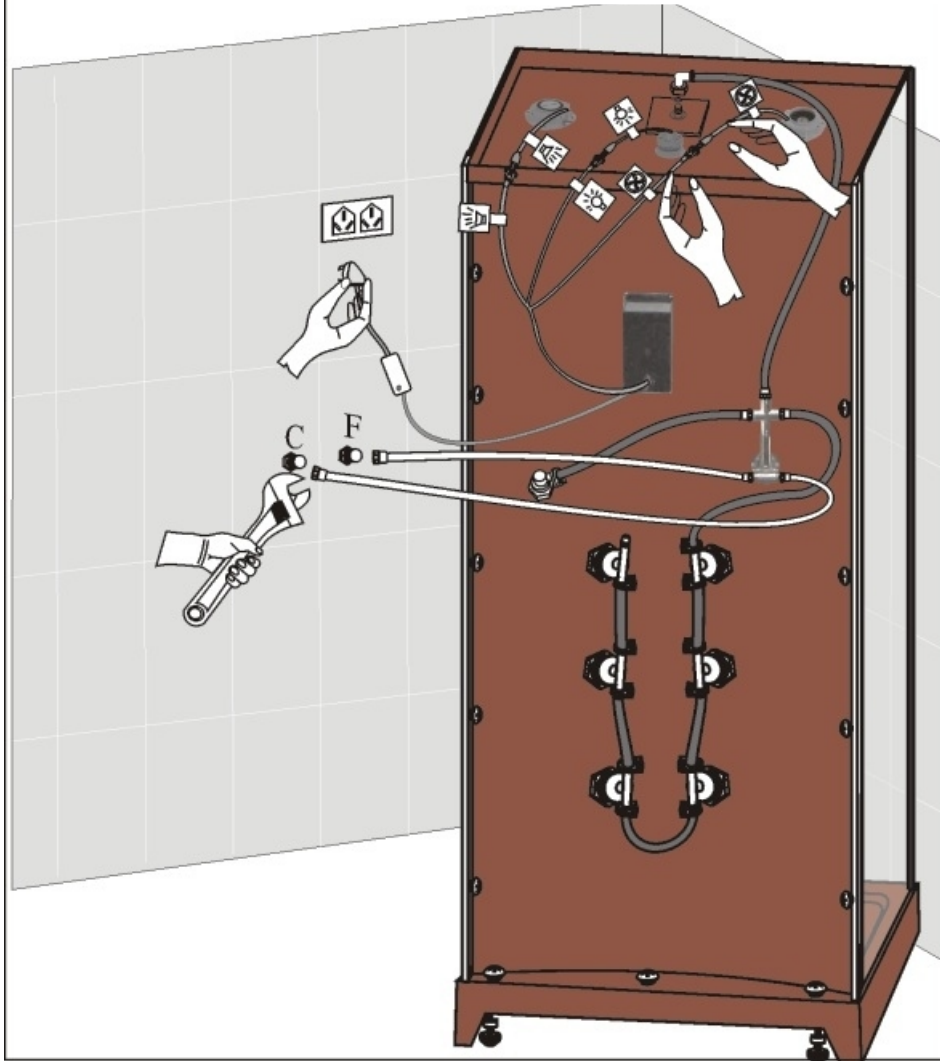

(15)

#### 五:Notes

1. It is unadvisable to take a shower after drunk.
2. It is unadvisable to have a shower immediately after acute sports.
3. Please avoid bath or shower in morning.
4. Keep the temperature of dressing room near to the bathroom'S
5. If you feel discomfortable while having a shower , you should go out of the shower room as soon as possible.
6. The time of shower is advisable to be between 15 minutes and 20 minutes, no longer .
7. Drink water to supplement moisture after shower or bathing.
8. People who suffer from heart disease, high blood pressure, diabetes or who feel unwell or pregnant woman are unadvisable to have bathing ,massage or shower.

#### 六:Deliverry and storage notice

- 1, It is prohibited to store organic solvent together, such as formic acid and methanol.
2. Handle with care if it need transport. Heavy stress, mechanical impact and sharp pounding is prohibited.
3. It should keep it dry and airy and make sure there is no etchant gas.

(16)

## 七, Trouble shootings

Troble	Cause	Remede
No power	1.Electric power don't connect well,leak swtich is cut off.	Access to power
	2.Fuse wire is broken,switch of control panel is failure.	Maintain or replace
	3.GFCI is out of work	Check GFCI
No head shower	1.water pressure is abnormal	Check water pressure
	2.Cold and hot water switch is closed.	Turn on the cold and hot water switch
	3.chocking nozzle	Clean
Water pipe leakage	1.Seal ring damaged	Replace seal ring
	2.Tie in don't connect well	Connect it again
No radio	1.Connecting wire is cut	Make connection
	2.Loudspeaker is broken	Replace a new one
Phone unuable	1.Telephone wire don't connect well	To make contact telephone line
	2.Control panel is broken	Maintain or replace
No light	1. Bulb is broken,ballast is broken	Replace
	2.Break of ballast	To make contact
	3.Control panel is broken	Maintain or replace
No exhaust	1.Fan is broken	Replace
	2.Tie-in is not connect well	To make contact
	3.Control panel is broken	Maintain or replace

If complete shower room cant work normally, please check it as compare above then obstacle avoidance.

If customers cant make sure the cause of obstacle or lack of ability mantianance.Please contact distributer.